

WARRANTY CERTIFICATE FOR THE HEATING MAT



TWIN-CONDUCTOR
HEATING MAT
ZUBR DC MAT

SELLER

THE LENGTH OF THE HEATING MAT · M
POWER · W
RESISTANCE · OHM
DATE, SIGNATURE, FULL NAME OF THE SELLER

BUYER

THE ADDRESS OF THE HEATING MAT INSTALLATION
DATE, SIGNATURE, FULL NAME OF THE BUYER

Due to the use of high-quality materials and modern technologies, the warranty period for the ZUBR DC Mat twin conductor mat is 25 years. These warranty obligations are valid if the terms of the warranty obligations are observed. A mandatory condition of the guarantee is the presence of the signature of the buyer and the seller.

INSTRUCTION

INSTALLATION AND OPERATION

Content

1. Purpose	4
2. Characteristics of the heating mat	4
3. Installation and security requirements	6
4. Selection of heating mat	7
5. Planning the layout of the heating mat	8
6. Preparation for installation	
6.1. Necessary materials and tools	10
6.2. Preparation of the floor surface	10
6.3. Preparation of the hole for the thermostat	10
7. Installation	
7.1. Thermal insulation	11
7.2. Laying the heating mat	12
7.3. Installation of a thermostat and a temperature sensor	12
7.4. Tile glue or screed	13
8. Activation and operation of the system	14
9. Scheme of laying a warm floor	14
10. Terms of warranty	16
Resistance measurement protocol	17

Thank you for choosing the ZUBR heating mat.
Please read this document carefully before starting installation.

1. Purpose

The ZUBR DC Mat twin-conductor heating mat is designed for installation not only in screed but also in tile adhesive, which is convenient when it is not possible to raise the floor height.

The specific power of the ZUBR mat is 160 W/m², ensuring perfect comfort and uniform distribution of heat over the entire surface of the floor. ZUBR heating mats can be used as an additional heating system.

Finishing coatings suitable for the ZUBR heating mat include:

- ceramic tile, porcelain stoneware, natural stone;
- laminate, provided that the temperature of the warm floor does not exceed 27 °C.

The laminate must have appropriate certificates and manufacturer's marks, which inform about the purpose of the product for use with an electric warm floor.

Spaces where the ZUBR heating mat can be installed include:

- living spaces: bathroom, kitchen, balcony, loggia, hallway in apartments and houses;
- non-residential premises: sauna, swimming pool, greenhouses, etc.

2. Characteristics of the ZUBR heating mat

The ZUBR heating mat is composed of a heating cable securely fixed with high-strength tape on a self-adhesive fiberglass reinforcing mesh. This design eliminates the need to select a laying step, reducing the risk of damage during installation. The distance between turns of the heating cable on the reinforcing grid is optimized for uniform and comfortable heating, measuring 9 cm.

The cable and the «cold» end are hermetically connected through a coupling. Inside the coupling, the two heating conductors and the screen are securely fixed in place with a special dielectric insulator.

Table 1. Technical characteristics of the ZUBR heating mat

Cable type	twin-conductor shielded
Cable diameter	3.6 mm
Width of the heating mat	0.5 m
Specific power	160 W/m ²
Length of the connecting wire	4 m Can be extended up to 30 m with copper wire 3 x 1.5 mm
Nominal supply voltage	230 V ~ 50 Hz
Maximum temperature	105 °C
Peak temperature	120 °C
Water protection class	IP X7
Insulation voltage test	2 500 V alternating current

Other technical characteristics of your specific heating mat are indicated on the package, including the length of each individual heating mat and the area for which it is suitable.

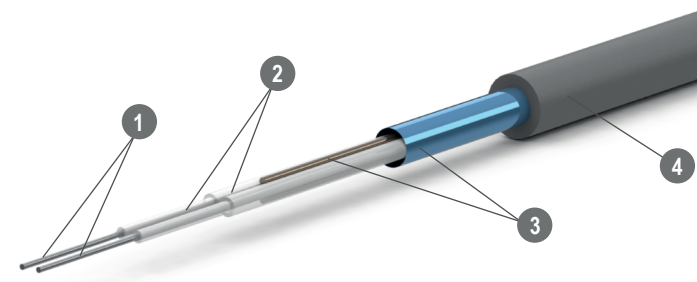

- 1 Two heating conductors**
The presence of two heating conductors allows for even distribution of temperature and ensures long-term operation of the warm floor.
- 2 Double layer FEP (fluoroethylene propylene) and HDPE (high-density polyethylene) insulation.**
The double-layer insulation on each conductor provides reliable protection for the cable during installation, especially when bending. The separate insulation of each heating conductor allows for free movement inside the wire, ensuring the durability of the structure.
- 3 Screen (two galvanized copper wires + aluminum and PET foil)**
The screen consists of two galvanized copper wires, as well as aluminum and PET foil.
- 4 The outer shell is made of cross-linked polyethylene (XLPE) with a thickness of 0.45 mm**
This ensures that there are no thin areas throughout the cable length, resulting in uniform heating.

3. Installation and security requirements

In case of violation of any of the listed requirements, the manufacturer withdraws its warranty obligations. The heating mat must be adopted in accordance with ZUBR recommendations.

Necessarily

- **Fill in the scheme of laying a warm floor on p. 15;**
- **Fill out the Resistance Measurement Protocol on p. 17;**
- The heating mat must be connected by a qualified electrician in accordance with all requirements of DBN and PUE;
- The heating mat must be grounded in accordance with the current rules of PUE and DBN;
- A thermostat must be connected to control the warm floor;
- To protect a person from damage by electric current leakage is mandatory install the PZV (protective shutdown device);
- To protect against a short circuit in front of the thermostat in the electrical panel an automatic switch is installed;
- To protect against voltage drops, use appropriate automation.

Forbidden

- **Shorten, lengthen, subject to mechanical tension and stretching of the heating element part of the heating mat;**
- **Turn on the heating mat rolled up;**
- Damage the integrity of the connecting coupling and insulation of the heating mat;
- Drive nails, dowels, screws into the surface of the warm floor;
- Use a damaged heating mat;
- Use the heating mat at ambient temperature below -5 °C;
- Connect the mat to an electrical network whose voltage does not correspond to the nominal value 230 V ~ 50 Hz;
- Perform work with the power supply turned on;
- Cover the warm floor with thick carpets and other insulating materials, put furniture on it without legs and with no air gap under them.

Recommended

- Mark the heating mat in the switchboard with warning signs inscriptions or signs

4. Selection of heating mat

When selecting a heating mat, it is important to consider the «free» area of the room where it will be installed.

The «free» area refers to the portion of the heated floor that is not occupied by stationary appliances or furniture. To calculate this area, exclude the space taken up by furniture without legs, sanitary ware, refrigerator, washing machine, shower cabin, bathtub, toilet, and so on.

Once you have determined the size of the «free» area, you can choose the appropriate heating mat. Please note that the width of all mats is 50 cm. For more detailed information, please refer to Table 2 below.

Table 2. ZUBR heating mat assortment

Laing area (m ²)	Mat length (m)	Power (V)
1,0	2,0	160
1,5	3,0	240
2,0	4,0	320
2,5	5,0	400
3,0	6,0	480
3,5	7,0	560
4,0	8,0	640
5,0	10,0	800
6,0	12,0	960
7,0	14,0	1 120
8,0	16,0	1 280
10,0	20,0	1 600
12,0	24,0	1 920
14,0	28,0	2 240
16,5	33,0	2 640

5. Planning the layout scheme for the heating mat

Before installing the heating mat, it is important to carefully plan its placement, following the basic installation rules:

- the heating mat should be placed in an area that is free from stationary furniture, household appliances, and sanitary ware;
- when laying the mats, ensure that they do not overlap each other;
- the mat should be laid out in a way that avoids crossing heating pipes, hot water supply pipes, temperature seams, and damping seams;
- if needed, the heating zone can be divided into multiple sections, and separate sections of the heating mat can be used for each zone.

It is crucial not to cut the cable!

To shape the heating mat as required, the grid should be cut very carefully to avoid damaging the cable.

Examples of laying a heating mat

You can rotate the cut mat at any angle to create L-shaped, U-shaped, and other shapes of heating. However, it is important to ensure that the step between the cables at the cut area of the mesh is consistent, as well as the pitch between the cables on the grid.

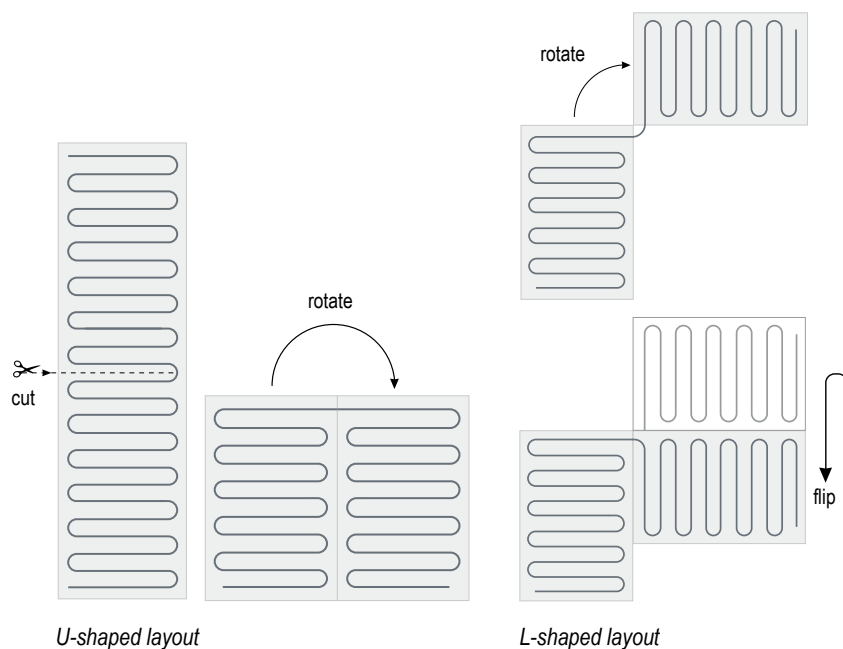

U-shaped layout

L-shaped layout

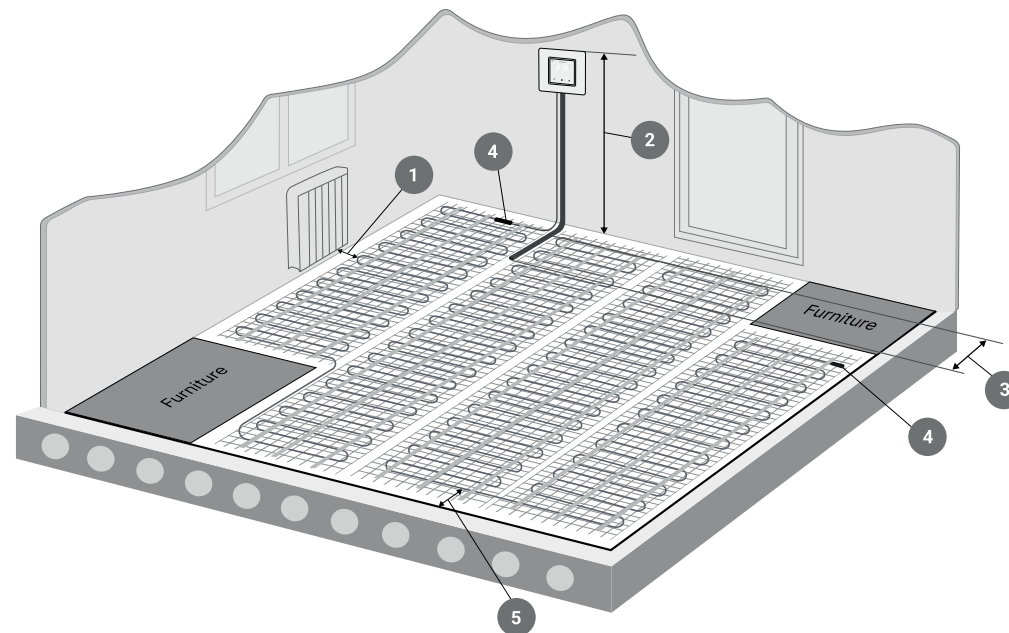

Fig.1 The example of laying the heating mat

- 1 **Maintain a minimum distance of 20 cm** between the mat cable and heating devices or heating pipes.
- 2 **The thermostat** is an essential component of the Warm floor system, ensuring a comfortable temperature. Install it at a height of 1.4-1.5 m from the floor level in a location where it won't be accidentally splashed. For energy-efficient electricity consumption, we recommend using a Smart Wi-Fi thermostat, such as the terneo sx.
- 3 **Place the temperature sensor** in the mounting tube between the cable turns and introduce it into the heating zone by 40-50 cm.
- 4 **Use cable clutch** for both connecting and end purposes.
- 5 **Maintain a minimum distance of 5 cm** between the cable and walls or other enclosing structures.

Make a layout diagram

To ensure compliance with warranty obligations, it is mandatory to create a layout diagram that includes the placement of all elements. Please record this diagram on page 15. The layout diagram will be useful for future construction works and when searching for possible damages.

6. Preparation for installation

6.1. Necessary materials and tools

A mounting tube

Designed for the installation and protection of the temperature sensor of the thermostat. The end of the tube must be closed with a plug or insulating tape to prevent any solution from entering it. A pipe with a plug is included in the warm floor set.

The tools required for installation

- screwdriver, pliers, nippers, an assembly knife, scissors, and a tape measure;
- perforator, hammer;
- multimeter (ohmmeter);
- megohmmeter.

6.2 Surface preparation

The base of the floor where the mat will be laid must be free of debris, dust, dirt, and sharp objects. It is recommended to prime the floor surface and allow it to dry before installation to ensure better adhesion to the next layer.

6.3 Preparation of the hole for the thermostat

Create a hole in the wall for the mounting box of the thermostat and make a vertical groove to the floor. Bring the «cold» ends of the heating mat to the mounting box and connect them to the thermostat using the connecting wire of the sensor.

Before installation, please ensure the following:

- check that the ambient temperature is within the acceptable limits for mat installation (6...36 °C);
- measure the resistance of the rolled mat and compare it with the nominal resistance indicated on the mat tags. The resistance error can be within -5 % to +10 %;
- enter the actual resistance in the Measurement Report on page 17.

7. Installation

7.1 Thermal insulation

Before starting the installation of the heating mat, you should take care of the installation of thermal insulation. It has an installation mandatory for rooms located on the first floor, above the garage, basement, unheated room, arches, etc. In other cases, thermal insulation is installed as desired, however its presence allows:

- increase the efficiency of underfloor heating;
- reduce heat loss of the room;
- save electricity.

Solid thermal insulation is installed on a flat, prepared floor surface with a thickness of 20 mm or more. The thicker the layer of thermal insulation, the less heat loss will be in the room.

Variants of heat-insulating material for underfloor heating:

1. Styrofoam with a density of at least 20 kg/m³;
2. Extruded polystyrene foam;

If it is not possible to place thermal insulation with a height of more than 20 mm, as a last resort use foamed polyethylene with a thickness of 5–7 mm

It is not recommended to use thermal insulation materials with a metal coating, such as aluminum foil.

To avoid pressing the heating mat into the surface of the thermal insulation, first fill it with a thin layer fire screed (7–10 mm).

Waterproofing. The placement of waterproofing is mandatory for rooms with high humidity.

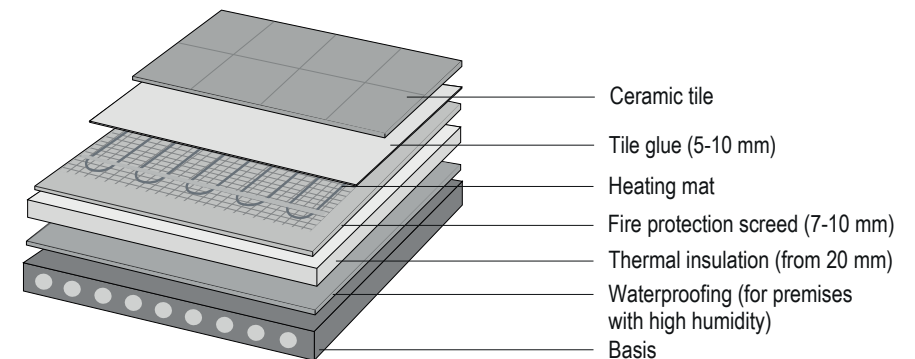

Fig. 2. The principle of laying the heating mat

7.2 Laying the heating mat

Bring the «cold» end of the mat to the location of the thermostat. Lay out the heating mat according to your layout scheme. Fix the grid of the unfolded heating mat with construction with tape or using a glue gun. Measure the resistance again and add to the Protocol on p. 17

Forbidden

- Step on or cover the assembled mat to avoid mechanical damage
- Plug in the mat in a roll without unwinding it, even for a short time
- Apply the heating mat in places subject to heavy mechanical loads or blows

7.3 Installation of the thermostat and sensor temperature

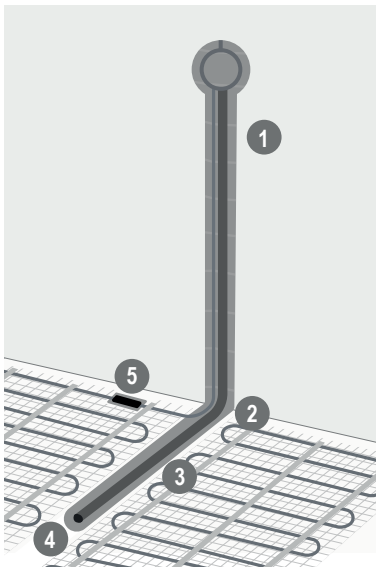

- 1 Make a strobe in the wall and floor and place it a temperature sensor in the mounting tube.
- 2 Bends of the tube should not interfere free movement of the sensor in case of replacement.
- 3 The sensor is installed at an equal distance between heating cable loops. For correct measure the temperature of the floor sensor into the heating zone by 40–50 cm.
- 4 Seal the end of the tube for preventing the solution from getting on the sensor. Make sure the sensor is at the end tubes.
- 5 Make a recess (groove) in the floor for of the coupling so that it does not increase the height of the self-leveling solution or tile glue.

Shorten or lengthen the connecting wires of the sensor as necessary. Made with a separate cable no more than 20 m.

Connect the 230 V power supply to the thermostat, taking into account that the wiring is standard (copper wire) withstands the following load currents:

- 1.5 mm² — 10 A;
- 2.5 mm² — 16 A;
- 4.0 mm² — 25 A.

7.4 Tile glue or screed

The heating mat can be laid to your choice: in tile adhesive for tiles, cement-sand solution or other mixtures for warm floors.

Tile glue is applied under finishing coatings with good thermal conductivity (ceramic tiles, natural stone, etc.) with a thickness of 5–10 mm, preventing the formation of air bubbles cavities and raising the mat. When applying and curing tile adhesive, the temperature of the base and the ambient air should be from +5 to +25 °C. In the room where the work will be performed, there shouldn't be any drafts.

A cement-sand solution (screed) is poured onto a heating mat up to 3–5 cm thick or concrete with a fine fraction of crushed stone (no more than 10 mm). We recommend adding to the solution softener.

You can also use construction mixtures or self-leveling solutions. Inadmissible use light concrete as a filling.

It is extremely important that the solution has a sufficiently liquid consistency to cover the entire mesh and cable it was completely filled and air cavities did not form around it, which can later cause local overheating of the mat.

To exclude cracking of the screed during operation, it is additionally possible use a reinforcing mesh and a damping tape, which is placed on the perimeter of the room between the wall and the floor.

Forbidden

- Use a heating mat without tile adhesive or screed;
- Destroy tile adhesive or screed;
- Turn on the warm floor until the tile adhesive or screed has completely hardened

Measure the resistance again (no need to wait for the screed to fully cure!) to check integrity mat and insulation. Add to the Protocol on p. 17.

Lay the finishing coating for the floor.

8. Turning on and operating the system

Connect the thermostat to the heating mat:

The shield of the heating mat (yellow-green wire) must be connected to the ground. Connect the two heating conductors (blue and brown wires) to the thermostat.

If you need to connect two or more heating mats to the thermostat, connect the wires of all the mats and the wires from the thermostat in a separate junction box. In this case, be sure to note that the total power of all heating mats must not exceed the maximum allowable power of the thermostat. Connect several cable sections to the thermostat/contactor in parallel.

The underfloor heating can only be switched on after the tile adhesive or screed has completely hardened. For cement-sand screeds, 28 days are required for full hardening according to the State Building Standards, for building mixtures and tile adhesive, the full hardening time is indicated on the packaging.

Check the electrical connection and turn on the thermostat to 26-28 °C, the first heating may take 5-50 hours. Please be patient and give the system time to warm up the room properly for the first time. Once the set temperature is reached, set the desired comfortable temperature. Do not cover the warm floor with thick carpets or rubber-based carpets — this may cause the mat to overheat.

Recommendations for choosing a comfortable temperature when using underfloor heating as the main type of heating

To save energy costs, we recommend maintaining at least the minimum floor temperature throughout the day during the cold season. Constantly maintaining the minimum temperature, even when no one is in the room, will be more efficient than turning off the underfloor heating and then warming up the system from scratch.

9. Layout scheme of the underfloor heating

Draw the layout: indicate the distance from the heating mat to the walls, furniture, sanitary equipment, the location of the thermostat and sensor, the connecting and end clutch, the «cold» end, and the direction of laying the mat, and indicate the power.

This scheme will be useful during subsequent construction work and the search for possible malfunctions.

Layout scheme for underfloor heating

NOTICE: Correct preparation of this drawing during the installation of the underfloor heating system is mandatory for the fulfillment of warranty obligations.

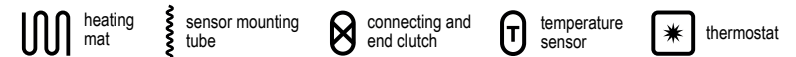
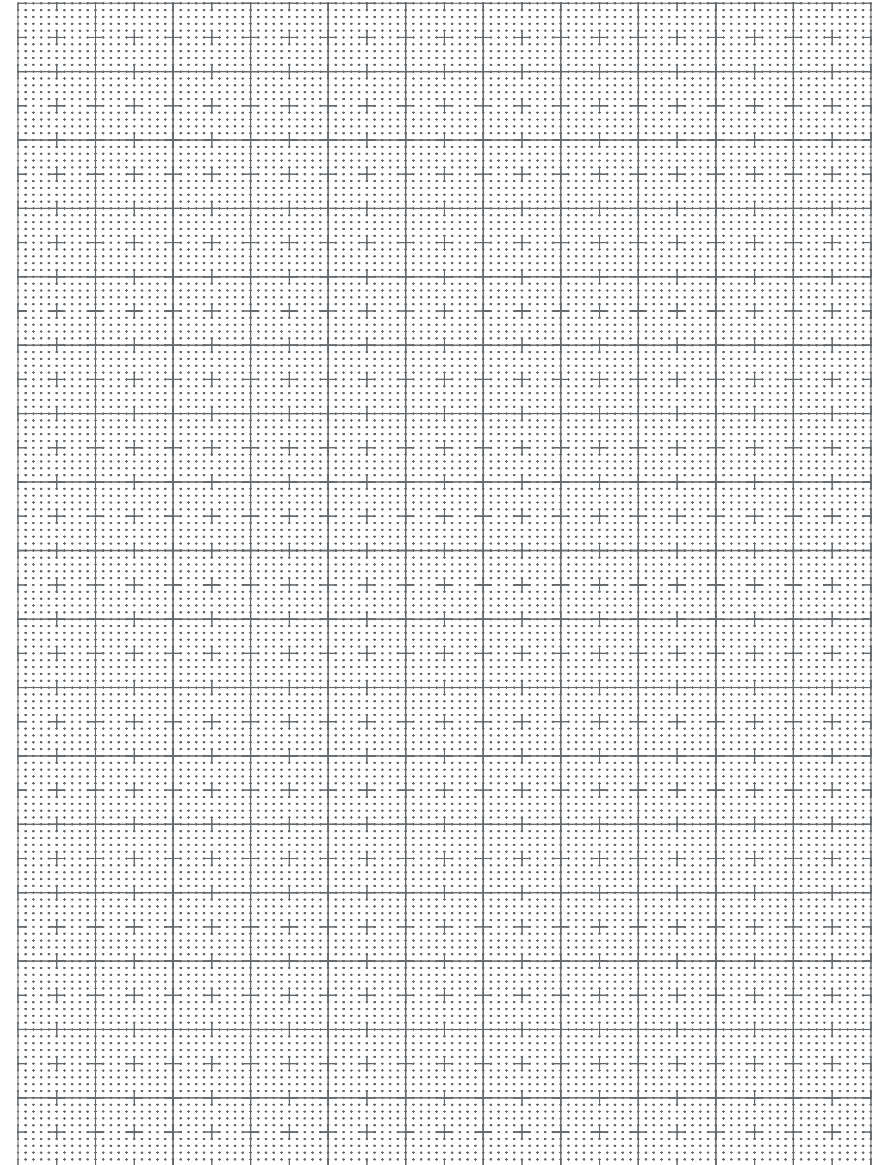

10. TERMS AND CONDITIONS OF WARRANTY OBLIGATIONS

1. If during the warranty period, a defect appears in the product due to its imperfect design, violation of manufacturing technology, or poor quality materials, the manufacturer guarantees free warranty repair of the defective product (or part thereof) if the buyer complies with the recommendations and requirements outlined in the Installation and Operation Manual.
2. The warranty does not apply to products installed and operated in violation of the Installation and Operation Manual, regardless of the cause of the defect.
3. The warranty does not apply to products with malfunctions caused by significant violations of the technical requirements specified in the Installation and Operation Manual, including instability of the power supply network parameters.
4. The warranty does not apply to products that have been damaged due to accidents, or negligent handling, during transportation and storage of the product. The risk of accidental breakdown or damage to the product passes to the buyer at the time of confirmation of acceptance of the product.
5. If during the warranty period, any part(s) of the product is replaced by part(s) that are not recommended for use or whose quality characteristics do not meet the requirements for the product, or if the product was repaired by a person not authorised to do so, the seller has the right to immediately terminate the warranty without further notice to the buyer.
6. This warranty gives the buyer the sole and exclusive right to repair (replace) the product, and its part(s), and no other rights, including the buyer's full liability in the event of accidental or unavoidable damage.
7. The manufacturer shall inspect the defective product and the heating system as a whole to determine their compliance with the requirements of the Installation and Operation Manual, followed by the preparation of a report on the causes of the defect. The seller's decision based on the results of the inspection is final.
8. The warranty repair of the product is carried out by a service center or an authorised person.
9. We recommend that you entrust the repair of the heating system only to organizations that are engaged in such work by the type of their activity.
10. For all warranty service issues, please contact your local retailer.

Manufacturer: ELEKTRA WŁODZIMIERZ NYC WITOLD NYC SPÓŁKA JAWNA,
05-850, Poland, Ozharuv Mazowiecki, 4 K. Kaminskoho str.

Service center on the territory of Ukraine: 04136, Ukraine, Kyiv, 1-3 Pivnichno-Syretska str.,
tel. +38 (044) 228-73-46, www.ds-electronics.com.ua

RESISTANCE MEASUREMENT PROTOCOL

The resistance measurement is performed 3 times to ensure the integrity of the heating mat. The resistance error can be within -5 / +10 %. **NOTICE: Completion of this protocol is mandatory for the fulfillment of warranty obligations.**

Length of the ZUBR DC Mat, in meters _____

BEFORE INSTALLING THE MAT

date of measurement _____

resistance of the heating core, Ohm _____

signature, and full name of the person who did the measurement

AFTER INSTALLING THE MAT

date of measurement _____

resistance of the heating core, Ohm _____

resistance between the heating core and the screen, Ohm _____

signature, and full name of the person who did the measurement

AFTER THE ADHESIVE OR SCREED IS Poured

date of measurement _____

resistance of the heating core, Ohm _____

resistance between the heating core and the screen, Ohm _____

signature, and full name of the person who did the measurement

